

Gastric Balloon Suction Catheter

DIRECTIONS FOR USE (DFU)

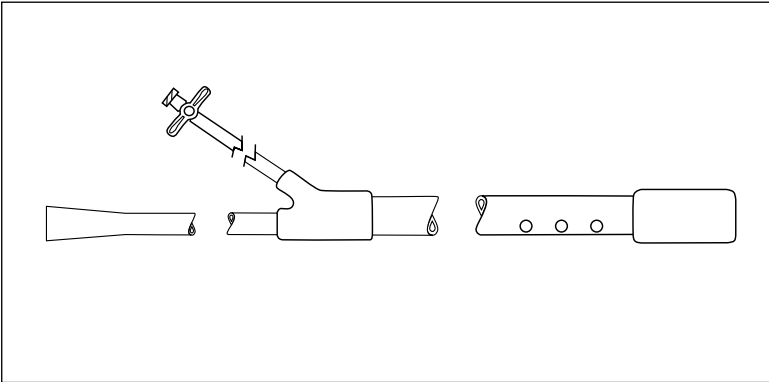

Rx Only

Gastric Balloon Suction Catheter

Gastric Balloon Suction Catheter Reference No. B-2020

The Gastric Balloon Suction Catheter is a flexible gastric tube designed to be used in Gastric and bariatric surgical procedures including gastrectomy, fundoplication, gastric banding, vertical banded gastroplasty and gastric bypass. The catheter provides visible and tactile delineation of the antrum of the stomach, drain and remove gastric fluid and size a gastric pouch.

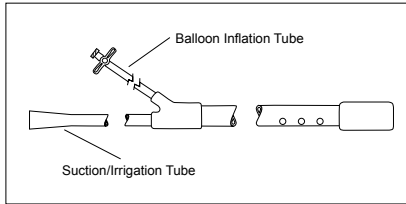

DESCRIPTION

The dual lumen Gastric Balloon Suction Catheter utilizes one lumen for drainage, suction and irrigation and the second lumen to inflate/deflate the fixation/calibration balloon. The catheter is 32 French and 53cm long with centimeter markings every 5cm from 30cm to 50cm. The catheter is attached to a 36 inch suction tubing and a 6-inch tubing with a stopcock for filling the balloon.

INDICATIONS

The Gastric Balloon Suction Catheter is indicated for use in gastric and bariatric surgical procedures to decompress the stomach, drain and remove gastric fluid and size the gastric pouch.

CONTRAINDICATIONS

The Gastric Balloon Suction Catheter is contraindicated when general or bariatric surgical procedures are contraindicated.

COMPLICATIONS

Complications which may result from the use of this product include the risks associated with the medications and methods utilized in the surgical procedure, the risks associated with any surgical procedure and the patient's degree of intolerance to a gastric tube.

SURGICAL PROCEDURE

Decompression

The Gastric Balloon Suction Catheter tube is inserted into the esophageal passage and advanced into the stomach. Once in the stomach, the distal end of the catheter is connected (with the suction/irrigation tubing connector) to standard low vacuum suction and the stomach is decompressed, removing air and/or gastric fluid.

Pouch Calibration

After decompression is completed and all air and fluids removed, the balloon attached to the catheter (with the one-way stopcock) is inflated with 12-25cc of air or saline and drawn up to the cardia. The

bulge created by the balloon can be seen and a visible boundary is established for gastric dissection, band placement or staple resection. After gastric dissection, band placement or staple resection, the balloon is deflated and the catheter is removed, the surgical procedure is then completed using standard techniques.

HOW SUPPLIED

The Gastric Balloon Suction Catheter is supplied non-sterile and for single use only.

Note: Do not autoclave the Gastric Balloon Suction Catheter, as this will damage the device.

RETURNED GOODS POLICY

Authorization must be received from your Apollo Account Manager prior to return of the merchandise. Merchandise returned must have all the manufacturer's seals intact to be eligible for credit or replacement. Products returned may be subject to restocking charges.

LIMITED WARRANTY, LIMITATION OF LIABILITY AND DISCLAIMER OF OTHER WARRANTIES

There is no express or implied warranty, including without limitation any implied warranty of merchantability or fitness for a particular purpose, on the Apollo Endosurgery, Inc. product(s) described in this publication. To the fullest extent permitted by applicable law, Apollo Endosurgery, Inc. disclaims all liability for any indirect, special, incidental, or consequential damages, regardless of whether such liability is based on contract, tort, negligence, strict liability, products liability or otherwise. The sole and entire maximum liability of Apollo Endosurgery, Inc., for any reason, and buyer's sole and exclusive remedy for any cause whatsoever, shall be limited to the amount paid by the customer for the particular items purchased. No person has the authority to bind Apollo Endosurgery, Inc. to any representation or warranty except as specifically set forth herein. Descriptions or specifications in Apollo Endosurgery, Inc. printed matter, including this publication, are meant solely to generally describe the product at the time of manufacture and do not constitute any express warranties or recommendations for use of the product in specific circumstances. Apollo Endosurgery, Inc. expressly disclaims any and all liability, including all liability for any direct, indirect, special, incidental, or consequential damages, resulting from reuse of the product.

The Gastric Balloon Suction Catheter contains no latex or natural rubber materials.

The Gastric Balloon Suction Catheter has US and international Patents Pending.







For additional information, please contact:

Manufacturer

Apollo Endosurgery, Inc.
1120 S. Capital of Texas Hwy
Bldg 1, Suite 300
Austin, TX 78746
Tel: (512) 279-5100
Fax: (512) 279-5105

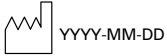
www.apolloendo.com

Caution: This device restricted to sale by or on the order of a physician.

	<p>Caution. See instructions for use.</p>
	<p>Single Use Only. Do Not Re-use.</p>
	<p>Lot Number</p>
	<p>Date of Manufacture, Year, Month, and Day</p>
	<p>Reference Number</p>
	<p>Product contains no latex</p>
<p>Rx Only</p>	<p>CAUTION: Federal Law (U.S.A.) restricts this device to sale by or on the order of a physician.</p>
	<p>Non-Sterile</p>
	<p>Do not use if package is damaged</p>



Manufacturer
Apollo Endosurgery, Inc.
1120 S. Capital of Texas Hwy
Bldg 1, Suite 300
Austin, TX 78746, U.S.A.

Assembled in U.S.A.

Tel: (512) 279-5100
Fax: (512) 279-5105

www.apolloendo.com

94650 Rev.08 06/2014
GRF-00253-00R01